

# KOBELCO

SK500LC/SK530LC-11

Performance  Design

## SK500<sub>LC</sub> SK530<sub>LC</sub>

- Bucket capacity:  
1.4 – 3.4 m<sup>3</sup>
- Engine power:  
300 kW / 1,900 min<sup>-1</sup>
- Operating weight:  
50,600 – 54,500 kg



Complies with the EU Stage V  
exhaust emission regulation

**We Save You Fuel**  
Achieving a Low-Carbon Society



# Performance X Design

SK500LC/SK530LC of KOBELCO has realised a completely new value by harmonising PERFORMANCE – greater efficiency and productivity with an increased power and speed and DESIGN – operator-based operability and comfort, refusing to accept any compromises.

In pursuit of unique and matchless machines which are unforgettable once you use them, KOBELCO will continue to rise to meet every challenge.



# THE ULTIMATE IN SIMPLE AND ELEGANT DESIGN

Our pursuit of functional beauty and aesthetic sense produced a new interior design.

## Jog dial

This jog dial integrates multiple functions to realise simple operations. Even with gloved hands, the operator can set various machine conditions without stress.

## LED backlights

The switches and dials have LED backlights – they provide a bright, clear view in the dark and set a luxurious mood.







# UNFORGETTABLE COMFORT

## ① Air suspension seat

A GRAMMER seat is installed as standard equipment, which achieves excellent shock absorption and superior ride comfort.

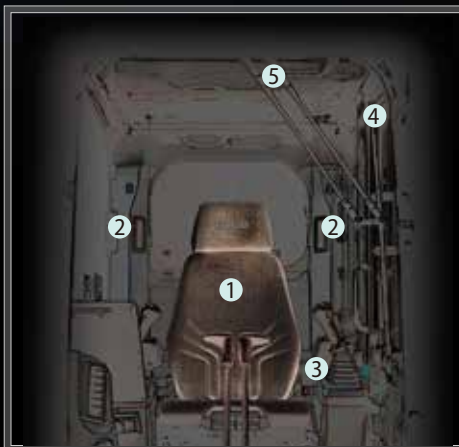

## ② Air conditioner blowing from the rear

Air is blown against the operator's waist and the back of their head, offering more comfortable operation.

## ③ Lever angles allow for comfortable operations

The operator can move the levers horizontally without twisting their wrist, which reduces the fatigue caused by the operations.



## New Hydraulic Control

Our newly upgraded hydraulic control system responds to shorter lever strokes than current models, delivering swifter, more precise movement and improved lever operability.

## ④ LED door light

The LED interior light automatically turns on when the door is opened or when the ignition is set to OFF. This ensures easy entry and exit at nighttime.

## ⑤ Parallel wipers secure a wide field of view



KOBELCO

ECO

04:33



SETTING MENU



PICTURE OF CAMERA



CLOCK SETTING



SCREEN BRIGHTNESS



MAINTENANCE



CONSUMPTION



LANGUAGE SELECTION



FLOW RATE 260 l/min



# A WIDER VIEW BRINGS A WIDER RANGE OF USE

## 10-inch colour monitor (the largest in the industry)

The easy-to-operate menu screen facilitates reading of important information. Images from the built-in cameras can be checked on the large screen, which helps secure safety. In addition, each icon has become easy to recognise. A password is required when starting the engine for greater security.



The right camera and rear camera (right side view mode)

The right camera and rear camera (straight view mode)

The right camera and rear camera (right side view mode)

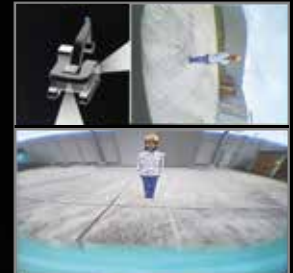

The right camera and rear camera (straight view mode)



The bird's-eye view



The eagle eye view

## Right, left and rear view cameras

Images from the right, left and rear view cameras are displayed together on the large colour monitor. The right camera view can be selected between the straight view mode and right side view mode.

In addition, the bird's-eye view mode and the eagle eye mode can also be selected.

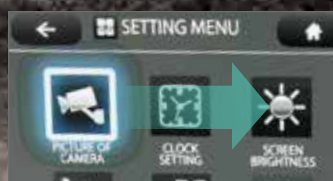

## Screen display linked with the jog dial operation

The jog dial can be operated as desired without causing stress. Turn the jog dial to the right or left to select an item and press the dial to confirm the selection.



## EXPERIENCING A COMPETENT PERFORMANCE

### Excellent machine stability, plus a Stage V compliant engine

Equipped with the new Stage V engine, the SK500LC/SK530LC features outstanding stability thanks to an innovative new shape for conventional excavator, as well as a larger counterweight.



Model: HINO E13CYM

Engine output

**300 kW / 1,900 min<sup>-1</sup>**

(ISO 14396)

### >>> Cycle time

(1. Digging 2. 90° swing 3. Dumping 4. 90° swing)

< H-mode >

**Shortened by 5.1%**

(Compared to H-mode on SK500LC-10)

### >>> Fuel consumption

(Fuel usage per hour)

< S-mode >

**Improved by 5.4%**

(Compared to S-mode on SK500LC-10)

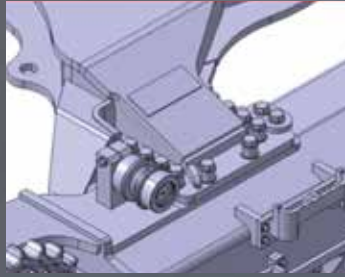

#### MVLC

Crawler width can be adjusted by fixing bolt positions to comply with transport regulations.  
\*MVLC is standard equipment for SK530LC.



### >>> Productivity

Digging volume/Fuel

< Eco-mode >

**Increased by 6.2%**

(Compared to Eco-mode on SK500LC-10)

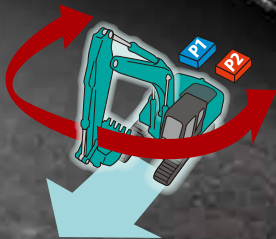

#### Independent Travel

Selecting Independent Travel dedicates one hydraulic pump to travel and one to the attachment on a continuous basis, allowing for a smooth and constant movement speed even while swinging or using the boom or attachment. With Independent Travel, safely carrying a large pipe across a job site is a breeze.



#### Heavy Lift

High hydraulic pressure (Heavy Lift) means greater lifting power, at close radius, allowing for smooth and steady operation while moving heavy objects.



#### Swing Priority

Our exclusive system automatically and instantly delivers full swing power during combined operations. There's no need to switch modes to make quick work of jobs like side-digging and back-filling.



# POWER PLANT DURABILITY YOU CAN TRUST

## Refined engine area for 50-ton class machines

The SK500LC and SK530LC machines are widely used in large-scale construction projects and harsh worksites. The power plant components have been reviewed and improvements have been made to their durability to ensure stable performance in such environments.



### Hydraulic drive for engine cooling / radiator fan; independent oil cooler fan

Hydraulic drive optimises the cooling fan rotation speed to improve fuel economy and reduce noise. Also, the independent oil cooler fan better matches cooling to the hydraulic oil temperature, for optimal oil temperature control.



### Added auto-tensioner to engine belt

With the addition of an auto-tensioner to the engine belt, the belt is kept taut, contributing to stable performance.

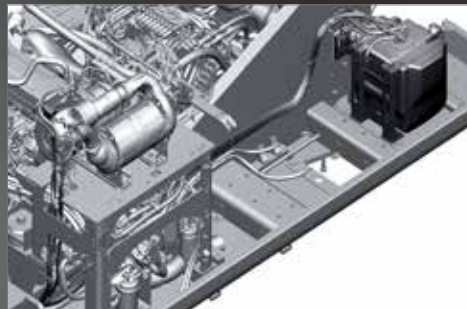

### Added electric heating wire to urea piping

An electric heating wire has been added to the urea piping to prevent urea from freezing in cold regions or in winter.

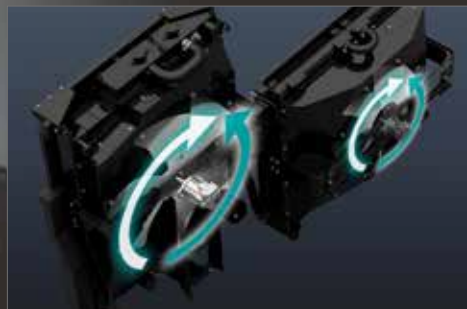

### Reversible fan

Both fans on the oil cooler and radiator can turn to the opposite direction. With one push from the cab, the hydraulic drive fans will blow out the dust. The direction will automatically switch back within a minute.

# GREATER MULTI-FUNCTION CAPABILITIES

## Attachment mode

The flow-rate modes of the bucket, breaker, nibbler, and rotating grapple are set before delivery, which allows you to start operating immediately. Mode settings for other attachments, such as the tilt rotator, can easily be added or changed.



## Adjustment for hydraulic flow

Divide ratio of hydraulic flow can be adjusted by service staff for custom usage.



# EASY MAINTENANCE



## Walk way (option)

A walk way is provided on the left side of the machine as option, allowing for easy inspection and cleaning of cooling system elements such as the radiator and oil cooler.



## Engine maintenance



## Two-stage air filter



## Urea tank

Urea filler cap is placed on the step for easy access.



## Radiator and oil cooling system

Laid out for easy access to radiator and cooling system.



## Pump compartment with clustered filters



## Drain filter



## Fuel filter and pre-filter



# KOBELCO MONITORING EXCAVATOR SYSTEM



## Remote Monitoring for Peace of Mind

KOMEXS (Kobelco Monitoring Excavator System) uses satellite communication and internet to relay data, and therefore can be deployed in areas where other forms of communication are difficult. When a hydraulic excavator is fitted with this system, data on the machine's operation, such as operating hours, location, fuel consumption, and maintenance status can be obtained remotely.

## Direct Access to Operational Status

### Location Data

Accurate location data can be obtained even from sites where communications are difficult.

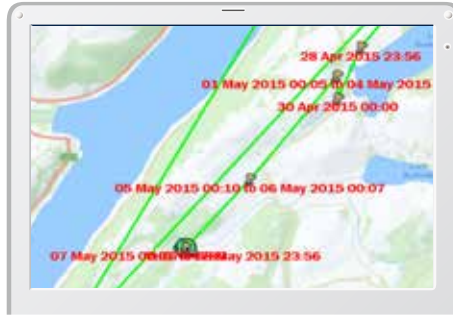
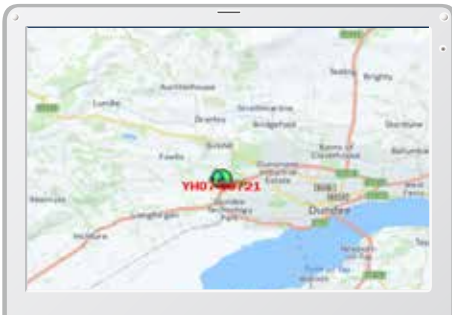

Work data

Period	11 Apr, 2015	to	10 May, 2015	Search
Type of Operation	Working Hrs		Ratio	
Total Working Hrs	159 Hrs		100 %	
Digging Hrs	72.2 Hrs		43 %	
Traveling Hrs	18.3 Hrs		11 %	
Idle Hrs	15.9 Hrs		9 %	
Opt Alt Hrs	52.5 Hrs		37 %	
Crane Mode Hrs	0 Hrs		0 %	



## Operating Hours

- A comparison of operating times of machines at multiple locations shows which locations are busier and more profitable.
- Operating hours on site can be accurately recorded, for running time calculations needed for rental machines, etc.

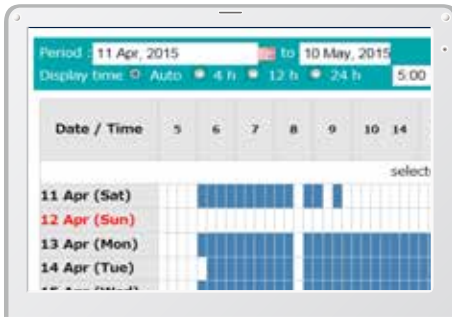

Daily report

## Fuel Consumption Data

Data on fuel consumption and idling times can be used to indicate improvements in fuel consumption.

Work mode	Working Hrs	Total Fuel Consumption
H mode	2:06	24.5 L
S mode	0:00	0.0 L
E mode	169:19	1489.7 L
<b>TOTAL</b>	<b>171:25</b>	<b>1514.2 L</b>

Fuel consumption

## Graph of Work Content

The graph shows how working hours are divided among different operating categories, including digging, idling, travelling and optional operations.



Work status

## Maintenance Data and Warning Alerts

### Machine Maintenance Data

- Provides maintenance status of separate machines operating at multiple sites.
- Maintenance data is also relayed to KOBELCO service personnel, for more efficient planning of periodic servicing.

Model	Serial No.	Hour Meter	Engine Oil
SK135SRLC-3/SK140SRL	YH07-09721	734 Hr	434
SK135SRLC-3/SK140SRL	YH07-09789	73 Hr	429
SK210LC-9	YQ13-10454	960 Hr	58
SK210LC-9	YQ13-10481	549 Hr	498
SK75SR-	YT08-20374		

Maintenance

### Warning Alerts

This system warns an alert if an anomaly is sensed, preventing damage that could result in machine downtime.

## Alarm Information Can Be Received through E-mail

Alarm information or maintenance notice can be received through E-mail, using a computer or cell phone.



Alarm messages can be received on mobile device.

## Daily/Monthly Reports

Operational data downloaded onto a computer helps in formulating daily and monthly reports.

## Security System

### Engine Start Alarm

The system can be set an alarm if the machine is operated outside designated time.

Engine start alarm outside prescribed work time

### Area Alarm

It can be set an alarm if the machine is moved out of its designated area to another location.

Alarm for outside of reset area

# Specifications

## SK500LC

SK500LC-11

## SK530LC

SK530LC-11



### Engine

Model	HINO E13CYM
Type	Water-cooled, 4-cycle 6-cylinder direct injection type diesel engine with intercooler turbo-charger (Stage V-compliant engine)
No. of cylinders	6
Bore and stroke	137 mm x 146 mm
Displacement	12.913 L
Rated power output	300 kW/1,900 min <sup>-1</sup> (ISO 14396: without fan)
Max. torque	1,700 N·m/1,400 min <sup>-1</sup> (ISO 14396: without fan)



### Hydraulic system

Pump	
Type	Two variable displacement piston pumps + fan pump + extra pump + pilot pump
Max. discharge flow	2 x 370 L/min 1 x 63.5 L/min, 1 x 62 L/min, 1 x 20 L/min
Relief valve setting	
Boom, arm and bucket	31.4 MPa
Power Boost	34.3 MPa
Travel circuit	34.3 MPa
Swing circuit	26.0 MPa
Control circuit	5.0 MPa
Pilot control pump	Gear type
Main control valves	8-spool
Oil cooler	Air cooled type



### Swing system

Swing motor	Two fixed displacement piston motor
Brake	Hydraulic; locking automatically when the swing control lever is in the neutral position
Parking brake	Wet multiple plate
Swing speed	7.5 min <sup>-1</sup>
Tail swing radius	3,800 mm
Swing torque	188 kN·m



### Attachments

Backhoe bucket and combination.

Use			Backhoe bucket					
			Normal digging			Light-duty		Mass excavating
Bucket capacity	ISO heaped	m <sup>3</sup>	1.4	1.6	1.9	2.1	2.4	3.4
	Struck	m <sup>3</sup>	1.0	1.15	1.4	1.5	1.7	2.9
Opening width	With side cutter	mm	1,225	1,375	1,670	1,750	1,980	1,990
	Without side cutter	mm	1,100	1,250	1,550	1,620	1,850	1,870
No. of teeth			4	4	5	5	5	6
Bucket weight		kg	1,250	1,310	1,510	1,560	1,690	2,340
Combination	3.0 m short arm		○	○	○	△	△	×
	3.45 m standard arm		○	○	◎	△	×	×
	4.04 m long arm		○	◎	△	×	×	×
	6.3 m ME boom and 2.4 m arm		×	×	×	×	×	○*

◎ Standard ○ Recommended △ Loading only × Not recommended

\*ME arm specs should be used for light-digging.



### Travel system

Travel motors	Variable displacement piston, two-speed motors
Travel brakes	Hydraulic brake
Parking brakes	Wet multiple plate
Travel shoes	50 each side
Travel speed	3.2/5.4 km/h
Drawbar pulling force	415 kN (ISO7464)
Gradeability	70% {35°}



### Cab & control

Cab	
All-weather, sound-suppressed steel cab mounted on the silicon-sealed viscous mounts and equipped with a heavy, insulated floor mat	
Control	
Two hand levers and two foot pedals for travel	
Two hand levers for excavating and swing	
Electric rotary-type engine throttle	
Noise levels	
External	106 dB(A) (2000/14/EC)
Operator	72 dB(A) (ISO 6396)
Vibration levels	
Hand/arm*	≤ 2.5 m/s <sup>2</sup>
Body*	≤ 0.5 m/s <sup>2</sup>

\*For the risk assessment according to 2002/44/EC, refer to ISO/TR 25398: 2006.



### Boom, arm & bucket

Boom cylinders	170 mm x 1,590 mm
Arm cylinder	190 mm x 1,970 mm
Bucket cylinder	160 mm x 1,410 mm
ME bucket cylinder	170 mm x 1,429 mm



### Refilling capacities & lubrications

Fuel tank	638 L
Cooling system	70 L
Engine oil	58 L
Travel reduction gear	2 x 15.0 L
Swing reduction gear	2 x 5.0 L
Hydraulic oil tank	371 L tank oil level
	631 L hydraulic system
DEF/Urea tank	83 L



## Working Ranges

Unit: m

Range	Arm	6.3 m ME		7.0 m	
		2.4 m ME	3.0 m Short	3.45 m Std	4.04 m Long
a- Max. digging reach		10.88	11.77	12.07	12.61
b- Max. digging reach at ground level		10.63	11.54	11.84	12.4
c- Max. digging depth		6.48	7.36	7.81	8.4
d- Max. digging height		10.92	11.16	10.93	11.14
e- Max. dumping clearance		6.92	7.72	7.58	7.79
f- Min. dumping clearance		3.11	3.22	2.77	2.18
g- Max. vertical wall digging depth		5.58	6.68	7.12	7.5
h- Min. swing radius		4.78	5.28	5.14	5.2
i- Horizontal digging stroke at ground level		3.59	5.21	6.1	7.07
j- Digging depth for 2.4 m (8') flat bottom		6.31	7.21	7.67	8.27
Bucket capacity ISO heaped m <sup>3</sup>		3.4	2.1	1.9	1.6

## Digging Force (ISO 6015)

Unit: kN

Arm length	2.4 m ME	3.0 m Short	3.45 m Std	4.04 m Long
Bucket digging force	288/312*	266/291*	267/292*	264/289*
Arm crowding force	247/270*	223/244*	203/222*	181/197*

\*Power Boost engaged.

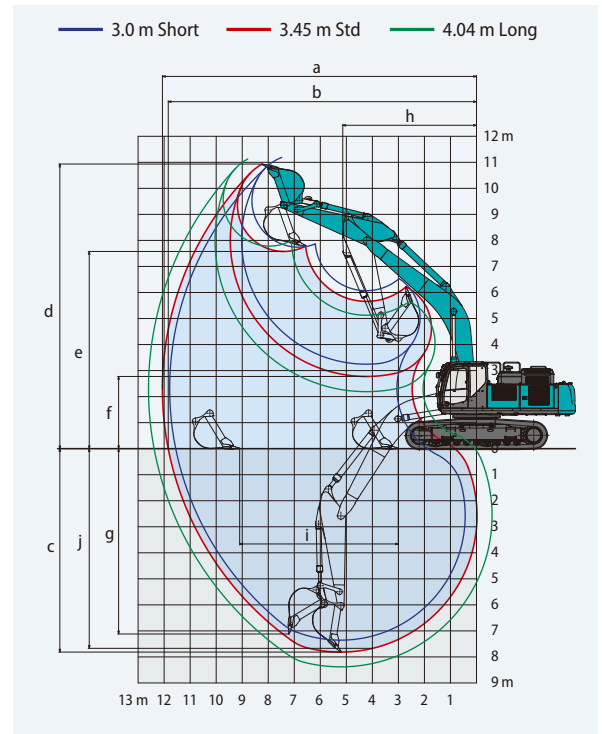

## Dimensions

Unit: mm

Arm length	2.4 m ME	3.0 m Short	3.45 m Standard	4.04 m Long
A Overall length	11,910	12,210	12,160	12,200
B Overall height (to top of boom)	4,240	3,800	3,620	3,760
C Overall width (with step)	3,350 (3,580)			
D Overall height (to top of cab)	3,380			
E Ground clearance of rear end*	1,260			
F Ground clearance*	505			
G Tail swing radius	3,880	3,800		
G' Distance from center of swing to rear end	3,880	3,800		
H Tumbler distance	4,400			
I Overall length of crawler	5,460			
J Track gauge	2,750			
K Shoe width	600			
L Overall width of upperstructure	2,980			

\*Without including height of shoe lug.

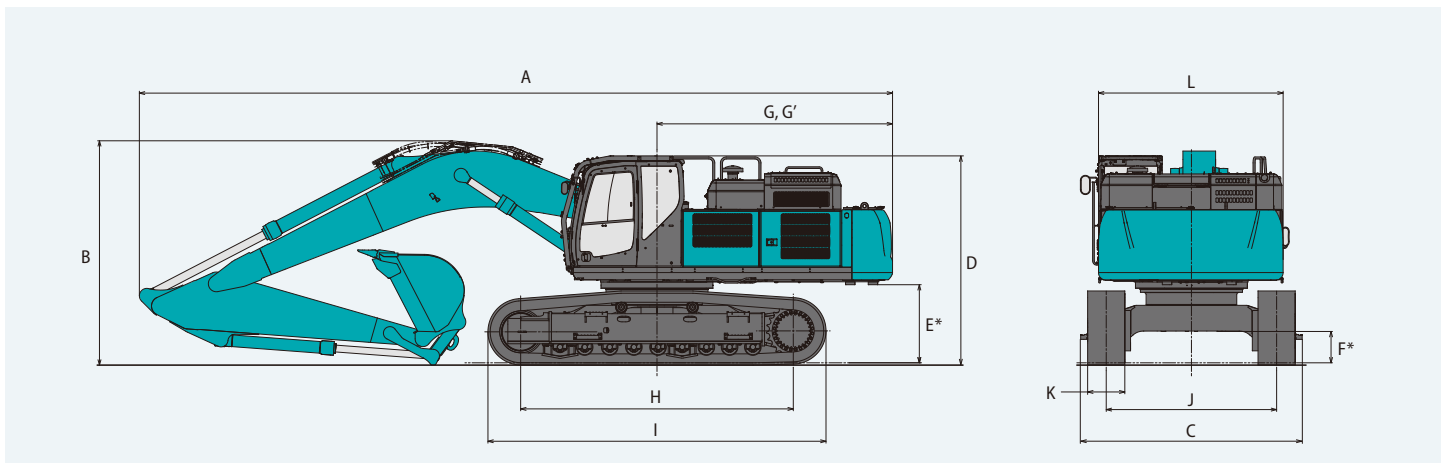

\*Without including height of shoe lug.



## Working Ranges

Unit: m

Range	Arm	6.3 m ME		7.0 m	
		2.4 m ME	3.0 m Short	3.45 m Std	4.04 m Long
a- Max. digging reach		10.88	11.77	12.07	12.61
b- Max. digging reach at ground level		10.61	11.51	11.82	12.37
c- Max. digging depth		6.36	7.24	7.69	8.28
d- Max. digging height		11.04	11.28	11.05	11.26
e- Max. dumping clearance		7.04	7.84	7.7	7.9
f- Min. dumping clearance		3.23	3.34	2.89	2.3
g- Max. vertical wall digging depth		5.46	6.56	7.0	7.38
h- Min. swing radius		4.78	5.28	5.14	5.2
i- Horizontal digging stroke at ground level		3.6	5.22	6.12	7.09
j- Digging depth for 2.4 m (8') flat bottom		6.19	7.09	7.55	8.15
Bucket capacity ISO heaped m <sup>3</sup>		3.4	2.1	1.9	1.6

## Digging Force (ISO 6015)

Unit: kN

Arm length	2.4 m ME	3.0 m Short	3.45 m Std	4.04 m Long
Bucket digging force	288/312*	266/291*	267/292*	264/289*
Arm crowding force	247/270*	223/244*	203/222*	181/197*

\*Power Boost engaged.

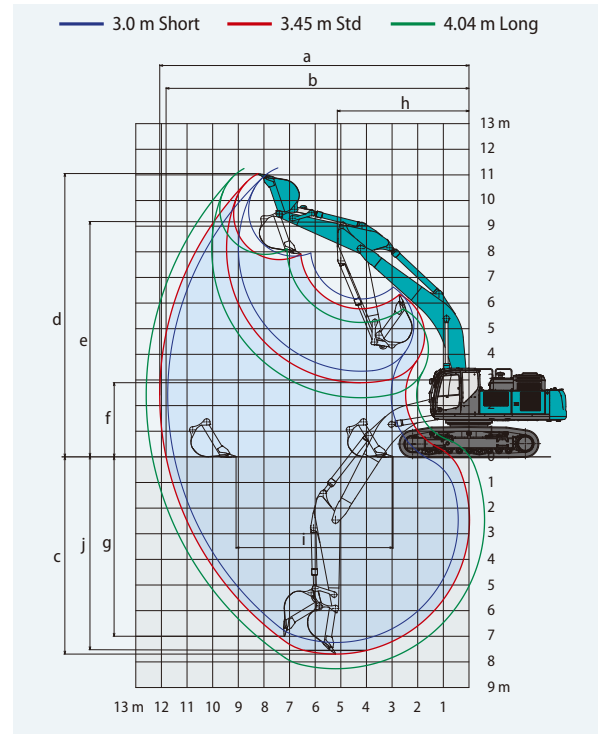

## Dimensions

Unit: mm

Arm length	2.4 m ME	3.0 m Short	3.45 m Standard	4.04 m Long
A Overall length	11,830	12,180	12,110	12,160
B Overall height (to top of boom)	4,290	3,820	3,630	3,750
C Overall width (with step / with VLC contracted)	3,490 (3,720/2,990)			
D Overall height (to top of cab)	3,500			
E Ground clearance of rear end*	1,380			
F Ground clearance*	740			
G Tail swing radius	3,800			
G' Distance from center of swing to rear end	3,800			
H Tumbler distance	4,400			
I Overall length of crawler	5,460			
J Track gauge (with VLC contracted)	2,890 (2,390)			
K Shoe width	600			
L Overall width of upperstructure	2,980			

\*Without including height of shoe lug.

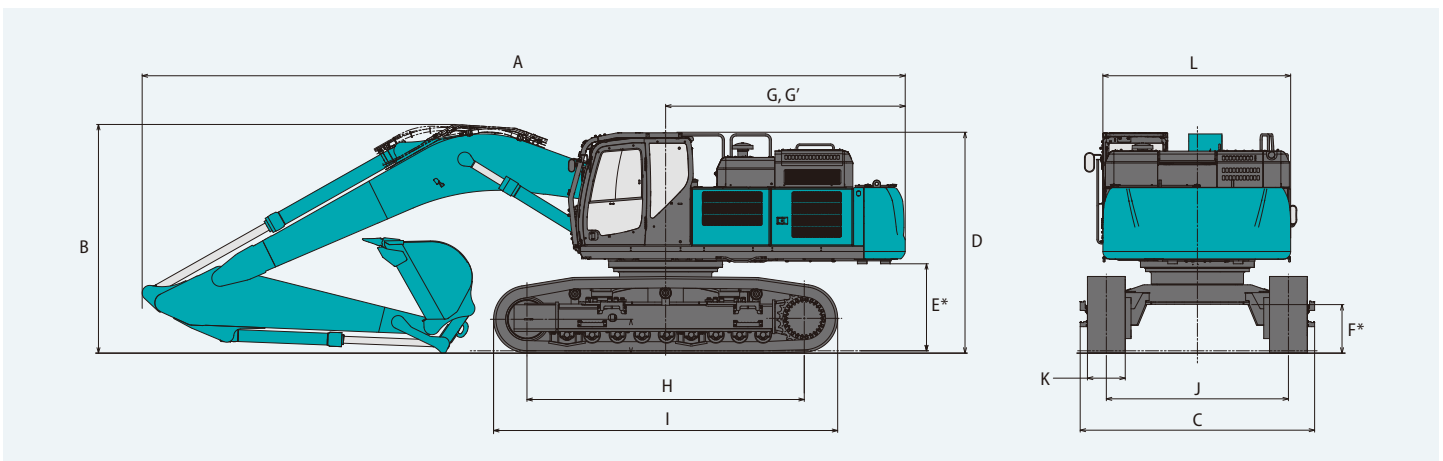

\*Without including height of shoe lug.

# Operating weight & ground pressure

**SK500LC**

SK500LC-11

**SK530LC**

SK530LC-11

## SK500LC

In standard trim, with standard boom, 3.45 m arm, 1.9 m<sup>3</sup> ISO heaped bucket.

Shaped		Double grouser shoes (even height)		Triple grouser shoes (even height)		
		HD		Standard		
Shoes width	mm	600		800	900	
Overall width of crawler	mm	3,350		3,550	3,650	
Ground pressure	kPa	87	87	87	67	60
Operating weight	kg	50,700	50,900	50,600	52,000	52,500

In standard trim, with 6.3 m ME boom, 2.4 m ME arm, 3.4 m<sup>3</sup> ISO heaped bucket, and heavier counterweight

Shaped		Double grouser shoes (even height)		Triple grouser shoes (even height)		
		HD		Standard		
Shoes width	mm	600		800	900	
Overall width of crawler	mm	3,350		3,550	3,650	
Ground pressure	kPa	90	91	90	69	62
Operating weight	kg	52,700	52,800	52,600	54,000	54,500

## SK530LC

In standard trim, with standard boom, 3.45 m arm, 1.9 m<sup>3</sup> ISO heaped bucket.

Shaped		Double grouser shoes (even height)		Triple grouser shoes (even height)		
		HD		Standard		
Shoes width	mm	600		800	900	
Overall width of crawler	mm	3,490 (2,990)		3,690 (3,190)	-	
Ground pressure	kPa	89	90	89	69	-
Operating weight	kg	52,100	52,300	52,100	53,400	-













In standard trim, with 6.3 m ME boom, 2.4 m ME arm, 3.4 m<sup>3</sup> ISO heaped bucket.













Shaped		Double grouser shoes (even height)		Triple grouser shoes (even height)		
		HD		Standard		
Shoes width	mm	600		800	900	
Overall width of crawler	mm	3,490 (2,990)		3,690 (3,190)	-	
Ground pressure	kPa	90	90	90	69	-
Operating weight	kg	52,500	52,700	52,500	53,800	-















# Lift capacities













# SK500LC

SK500LC-11

SK500LC		Boom: 7.0 m		Arm: 3.45 m		Bucket: without		Counterweight: 9,800 kg		Shoe: 600 mm (Heavy Lift)						
B	A	3.0 m		4.5 m		6.0 m		7.5 m		9.0 m		At max. reach		Radius		
																
9.0 m	kg													*10,300	*10,300	7.76 m
7.5 m	kg													*10,080	9,080	8.86 m
6.0 m	kg								*10,640	*10,640	*10,120	8,780	*9,880	7,850	9.59 m	
4.5 m	kg			*18,010	*18,010	*13,790	*13,790	*11,720	11,290	*10,600	8,550	*9,970	7,140	10.04 m		
3.0 m	kg			*22,740	22,120	*16,080	14,750	*12,980	10,770	*11,270	8,270	*10,320	6,770	10.26 m		
1.5 m	kg			*14,790	*14,790	*17,950	13,980	*14,120	10,310	*11,920	8,010	10,630	6,650	10.25 m		
G.L.	kg			*18,080	*18,080	*19,010	13,530	*14,890	10,000	*12,350	7,830	10,900	6,790	10.01 m		
-1.5 m	kg	*13,040	*13,040	*25,670	20,470	*19,180	13,370	*15,090	9,860	*12,320	7,760	*11,430	7,230	9.53 m		
-3.0 m	kg	*22,230	*22,230	*24,070	20,690	*18,390	13,440	*14,500	9,910			*11,770	8,140	8.76 m		
-4.5 m	kg	*28,040	*28,040	*21,070	*21,070	*16,290	13,750	*12,320	10,220			*11,940	10,020	7.62 m		

SK500LC		Boom: 7.0 m		Arm: 3.0 m		Bucket: without		Counterweight: 9,800 kg		Shoe: 600 mm (Heavy Lift)						
B	A	3.0 m		4.5 m		6.0 m		7.5 m		9.0 m		At max. reach		Radius		
																
9.0 m	kg													*11,240	*11,240	7.36 m
7.5 m	kg								*10,750	*10,750				*10,880	9,590	8.51 m
6.0 m	kg								*11,280	*11,280	*10,750	8,690	*10,800	8,230	9.27 m	
4.5 m	kg			*19,600	*19,600	*14,610	*14,610	*12,300	11,190	*11,100	8,500	*10,870	7,470	9.74 m		
3.0 m	kg					*16,810	14,580	*13,480	10,700	*11,680	8,250	*11,030	7,080	9.96 m		
1.5 m	kg					*18,480	13,890	*14,500	10,290	*12,230	8,020	11,140	6,980	9.95 m		
G.L.	kg			*13,600	*13,600	*19,260	13,540	*15,120	10,030	*12,520	7,880	11,470	7,150	9.70 m		
-1.5 m	kg	*10,220	*10,220	*23,790	20,650	*19,140	13,460	*15,120	9,940	*12,200	7,880	*11,770	7,680	9.20 m		
-3.0 m	kg	*22,180	*22,180	*23,240	20,930	*18,020	13,590	*14,180	10,050			*11,920	8,760	8.41 m		
-4.5 m	kg	*25,290	*25,290	*19,730	*19,730	*15,340	13,990					*11,700	11,030	7.21 m		

SK500LC		Boom: 7.0 m		Arm: 4.04 m		Bucket: without		Counterweight: 9,800 kg		Shoe: 600 mm (Heavy Lift)								
B	A	1.5 m		3.0 m		4.5 m		6.0 m		7.5 m		9.0 m		10.5 m		At max. reach	Radius	
																		
9.0 m	kg															*8,740	*8,740	8.47 m
7.5 m	kg										*9,070	8,970				*8,300	8,140	9.48 m
6.0 m	kg										*9,290	8,840				*8,160	7,120	10.17 m
4.5 m	kg									*10,860	*10,860	*9,880	8,570	*9,080	6,630	*8,230	6,520	10.60 m
3.0 m	kg					*20,670	*20,670	*14,950	14,940	*12,200	10,810	*10,640	8,250	*9,740	6,480	*8,490	6,180	10.80 m
1.5 m	kg					*19,900	*19,900	*17,060	14,040	*13,460	10,290	*11,400	7,940	*10,110	6,330	*8,980	6,070	10.79 m
G.L.	kg			*6,600	*6,600	*19,640	*19,640	*18,450	13,460	*14,420	9,910	*11,980	7,710	10,060	6,220	*9,760	6,160	10.57 m
-1.5 m	kg	*8,680	*8,680	*12,720	*12,720	*24,690	20,170	*18,970	13,190	*14,860	9,700	*12,190	7,590			10,570	6,510	10.11 m
-3.0 m	kg	*14,920	*14,920	*19,840	*19,840	*24,750	20,290	*18,600	13,170	*14,630	9,670	*11,740	7,610			*10,980	7,230	9.39 m
-4.5 m	kg			*29,260	*29,260	*22,390	20,660	*17,100	13,380	*13,310	9,850					*11,280	8,620	8.35 m
-6.0 m	kg					*18,000	*18,000	*13,600	*13,600							*11,220	*11,220	6.81 m

SK500LC		Boom: 6.3 m		Arm: 2.4 m		Bucket: without		Counterweight: 11,200 kg		Shoe: 600 mm (Heavy Lift)						
B	A	3.0 m		4.5 m		6.0 m		7.5 m		9.0 m		At max. reach		Radius		
																
9.0 m	kg													*14,040	*14,040	5.63 m
7.5 m	kg													*11,950	*11,950	7.07 m
6.0 m	kg								*14,030	*14,030	*13,030	12,460	*11,050	*11,050	7.97 m	
4.5 m	kg								*15,720	*15,720	*13,590	12,150	*10,690	9,990	8.52 m	
3.0 m	kg								*17,670	16,000	*14,490	11,750	*10,720	9,410	8.77 m	
1.5 m	kg								*19,140	15,400	*15,270	11,410	*11,110	9,300	8.76 m	
G.L.	kg					*19,660	15,110	*15,530	11,230	*11,960	9,660			8.48 m		
-1.5 m	kg			*24,920	23,060	*19,030	15,110	*14,760	11,290	*13,450	10,650			7.90 m		
-3.0 m	kg	*27,770	*27,770	*21,770	*21,770	*16,670	15,420			*13,050	12,850			6.95 m		

**Notes:**

- Do not attempt to lift or hold any load that is greater than these lift capacities at their specified lift point radius and heights. Weight of all accessories must be deducted from the above lift capacities.
- Lift capacities are based on machine standing on level, firm, and uniform ground. User must make allowance for job conditions such as soft or uneven ground, out of level conditions, side loads, sudden stopping of loads, hazardous conditions, experience of personnel, etc.
- Arm top defined as lift point.

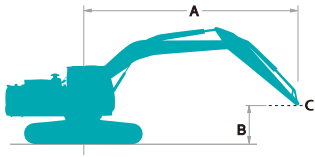

Rating over front



Rating over side or 360 degrees

A - Reach from swing centerline to arm top

B - Arm top height above/below ground

C - Lift point

Relief valve setting: 34.3 MPa

# SK530LC

SK530LC-11

SK530LC		Boom: 7.0 m		Arm: 3.45 m		Bucket: without		Counterweight: 9,800 kg		Shoe: 600 mm (Heavy Lift)				
B	A	3.0 m		4.5 m		6.0 m		7.5 m		9.0 m		At max. reach		Radius
9.0 m	kg											*10,270	*10,270	7.87 m
7.5 m	kg											*10,050	9,600	8.93 m
6.0 m	kg							*10,720	*10,720	*10,140	9,390	*9,880	8,350	9.63 m
4.5 m	kg			*18,400	*18,400	*13,970	*13,970	*11,820	*11,820	*10,650	9,160	*9,990	7,640	10.07 m
3.0 m	kg			*21,440	*21,440	*16,250	15,830	*13,080	11,540	*11,330	8,870	*10,360	7,270	10.27 m
1.5 m	kg			*14,820	*14,820	*18,070	15,070	*14,200	11,090	*11,970	8,620	*10,760	7,180	10.24 m
G.L.	kg			*18,550	*18,550	*19,060	14,640	*14,930	10,790	*12,370	8,440	*11,090	7,350	9.98 m
-1.5 m	kg	*13,720	*13,720	*25,590	22,330	*19,150	14,490	*15,080	10,660	*12,290	8,390	*11,460	7,860	9.48 m
-3.0 m	kg	*23,050	*23,050	*23,890	22,580	*18,280	14,580	*14,410	10,720			*11,790	8,900	8.69 m
-4.5 m	kg	*27,540	*27,540	*20,750	*20,750	*16,040	14,920	*11,990	11,080			*11,930	11,050	7.51 m

SK530LC		Boom: 7.0 m		Arm: 3.0 m		Bucket: without		Counterweight: 9,800 kg		Shoe: 600 mm (Heavy Lift)				
B	A	3.0 m		4.5 m		6.0 m		7.5 m		9.0 m		At max. reach		Radius
9.0 m	kg											*11,200	*11,200	7.47 m
7.5 m	kg							*10,760	*10,760			*10,870	10,120	8.58 m
6.0 m	kg							*11,350	*11,350	*10,760	9,310	*10,800	8,750	9.32 m
4.5 m	kg			*20,010	*20,010	*14,790	*14,790	*12,390	11,970	*11,140	9,110	*10,880	7,990	9.77 m
3.0 m	kg					*16,970	15,650	*13,570	11,470	*11,730	8,860	*11,040	7,610	9.97 m
1.5 m	kg					*18,580	14,980	*14,570	11,070	*12,270	8,630	*11,270	7,530	9.94 m
G.L.	kg			*14,280	*14,280	*19,290	14,650	*15,140	10,820	*12,520	8,500	*11,530	7,750	9.67 m
-1.5 m	kg	*11,170	*11,170	*24,790	22,520	*19,090	14,580	*15,080	10,740	*12,130	8,510	*11,780	8,350	9.15 m
-3.0 m	kg	*23,220	*23,220	*23,030	22,830	*17,870	14,740	*14,040	10,880			*11,920	9,570	8.33 m
-4.5 m	kg			*19,340	*19,340	*15,010	*15,010					*11,650	*11,650	7.10 m

SK530LC		Boom: 7.0 m		Arm: 4.04 m		Bucket: without		Counterweight: 9,800 kg		Shoe: 600 mm (Heavy Lift)								
B	A	1.5 m		3.0 m		4.5 m		6.0 m		7.5 m		9.0 m		10.5 m		At max. reach	Radius	
9.0 m	kg															*8,690	*8,690	8.57 m
7.5 m	kg											*9,070	*9,070			*8,280	*8,280	9.55 m
6.0 m	kg											*9,330	*9,330			*8,160	7,590	10.21 m
4.5 m	kg							*12,750	*12,750	*10,960	*10,960	*9,940	9,180	*9,270	7,130	*8,240	6,980	10.62 m
3.0 m	kg					*21,020	*21,020	*15,140	*15,140	*12,300	11,580	*10,700	8,850	*9,770	6,980	*8,520	6,660	10.81 m
1.5 m	kg					*19,530	*19,530	*17,200	15,120	*13,550	11,070	*11,450	8,550	*10,130	6,830	*9,030	6,560	10.78 m
G.L.	kg			*7,070	*7,070	*19,900	*19,900	*18,520	14,560	*14,470	10,690	*12,010	8,320	*10,310	6,720	*9,840	6,690	10.54 m
-1.5 m	kg	*9,180	*9,180	*13,240	*13,240	*25,250	22,020	*18,980	14,310	*14,870	10,490	*12,190	8,200			*10,630	7,090	10.07 m
-3.0 m	kg	*15,440	*15,440	*20,480	*20,480	*24,620	22,160	*18,530	14,300	*14,580	10,480	*11,650	8,250			*11,000	7,900	9.32 m
-4.5 m	kg			*30,180	*30,180	*22,130	*22,130	*16,920	14,540	*13,120	10,680					*11,290	9,480	8.24 m
-6.0 m	kg					*17,510	*17,510	*13,150	*13,150							*11,180	*11,180	6.66 m

SK530LC		Boom: 6.3 m		Arm: 2.4 m		Bucket: without		Counterweight: 9,800 kg		Shoe: 600 mm (Heavy Lift)				
B	A	3.0 m		4.5 m		6.0 m		7.5 m		9.0 m		At max. reach		Radius
9.0 m	kg											*13,790	*13,790	5.77 m
7.5 m	kg											*11,850	*11,850	7.16 m
6.0 m	kg							*14,130	*14,130	*13,040	12,260	*11,000	10,910	8.03 m
4.5 m	kg							*15,870	*15,870	*13,650	11,930	*10,680	9,740	8.55 m
3.0 m	kg							*17,810	15,740	*14,560	11,520	*10,740	9,200	8.78 m
1.5 m	kg							*19,220	15,150	*15,310	11,190	*11,160	9,130	8.74 m
G.L.	kg							*19,660	14,890	*15,520	11,030	*12,050	9,520	8.44 m
-1.5 m	kg					*24,740	22,940	*18,920	14,910	*14,620	11,110	*13,440	10,570	7.84 m
-3.0 m	kg	*27,280	*27,280	*21,420	*21,420	*16,360	15,260					*12,980	12,910	6.86 m

4. The above lift capacities are in compliance with ISO 10567. They do not exceed 87% of hydraulic lift capacity or 75% of tipping load. Lift capacities marked with an asterisk (\*) are limited by hydraulic capacity rather than tipping load.  
 5. Operator should be fully acquainted with the Operator's and Maintenance Instructions before operating this machine. Rules for safe operation of equipment should be adhered to at all times.  
 6. Lift capacities apply to only machine as originally manufactured and normally equipped by KOBELCO CONSTRUCTION MACHINERY CO., LTD.

# Standard and Optional Equipment

● = Std ○ = Opt. - = not available

Category	Description	SK500LC-11		SK530LC-11	
		Standard	Mass excavation	Standard	Mass excavation
CAB	Cab (ROPS)(ISO 12117-2:2008)	●	●	●	●
FRONT GUARD	Front guard (OPG Level II)(ISO 10262;1998)	○	○	○	○
SEAT	Airsuspension seat + heater	●	●	●	●
SHOE	600mm triple grouser shoe	●	●	●	●
	600mm double grouser HD shoe	○	○	○	○
	600mm triple grouser HD shoe	○	○	○	○
	800mm steel shoe	○	○	○	○
	900mm steel shoe	○	○	-	-
BOOM	Standard HD boom (7.00m) with two LED lights	●	-	●	-
	Standard ME boom (6.30m) with two LED lights	-	●	-	●
ARM	Standard HD arm (3.45m) with rock guard	●	-	●	-
	Short HD arm (3.00m) with rock guard	○	-	○	-
	Semi long HD arm (4.04m) with rock guard	○	-	○	-
	Standard ME arm (2.40m) with rock guard	-	●	-	●
PIPING	Standard piping (Less E&N&B, Less OHK, Less QH piping)	-	●	-	●
	N&B piping + OHK + QH piping	○	○	○	○
	E&N&B piping + OHK + QH piping	●	-	●	-
CONTROL SYSTEM	Proportional Hand Control (for N&B piping)	○	○	○	○
	Proportional Hand Control (for E&N&B piping)	●	-	●	-
C/W	Semi heavier C/W (total 9,800kg)	●	-	●	●
	Heavier C/W (total 11,200kg)	-	●	-	-
OTHER	Cab top LED work lights (two lights)	○	○	○	○
	Rain visor	○	○	○	○
	Sun screen	○	○	○	○
	Additional track guides (two additional per side)	○	○	○	○
	Travel alarm	○	○	○	○
	Walk way	○	○	○	○
	Hydraulic oil VG46	○	○	○	○
	Hydraulic oil VG68	○	○	○	○
	RAL color	○	○	○	○
	BASE MACHINE EQUIPMENT	Fixed undercarriage	●	●	-
MVLC (Mechanical variable undercarriage)		-	-	●	●
Top guard (OPG Level II)(ISO 10262;1998)		●	●	●	●
Hydraulic oil VG32		●	●	●	●
Air-conditioner		●	●	●	●
DAB+ radio (FM/AM & AUX & USB & bluetooth & hands free telephone)		●	●	●	●
Harness for CAB four lights and CAB yellow flasher		●	●	●	●
Harness for engine room light		●	●	●	●
Eagle-eye view camera (Rear, Right, Left)		●	●	●	●
Refueling pump		●	●	●	●
Reversible hydraulic drive cooling fan		●	●	●	●
Lower frame guard		●	●	●	●
Track guides (two per side)		●	●	●	●
LED work light (one on upper frame)		●	●	●	●
KOMEXS		●	●	●	●
Bucket less	●	●	●	●	

Note: This catalogue may contain attachments and optional equipment that are not available in your area. And it may contain photographs of machines with specifications that differ from those of machines sold in your areas. Please consult your nearest KOBELCO distributor for those items you require. Due to our policy of continuous product improvements all designs and specifications are subject to change without advance notice.

Copyright by **KOBELCO CONSTRUCTION MACHINERY CO., LTD.** No part of this catalogue may be reproduced in any manner without notice.

## KOBELCO CONSTRUCTION MACHINERY EUROPE B.V.

Veluwezoom 15  
1327 AE Almere  
The Netherlands  
www.kobelco-europe.com

Enquiries To: